



WARNING

ENG – The RemDry system needs to be used according to local environmental regulations and to be placed at a safe distance from water courses and roads, work areas, domestic areas and animal holding areas on farms.

Proper waste treatment centers need to be available.

During all the use phases below described, wear the personal protection equipment (PPE) to protect yourself preventing any potential injuries and/or body contamination

BUL – RemDry трябва да се използва в съответствие с местните екологични разпоредби и да се поставя на безопасно разстояние от водните пътища и пътищата, работните зони, жилищните зони и зоните за задържане на животните във фермите.

Трябва да има подходящи центрове за третиране на отпадъци.

Използвайте всички лични предпазни средства (ЛПС), за да се предпазите от евентуално нараняване и / или замърсяване на тялото на всички етапи на употреба, описани по-долу.

ESP – El sistema RemDry debe usarse de acuerdo con las regulaciones ambientales locales y debe ubicarse a una distancia segura de los cursos de agua y carreteras, áreas de trabajo, áreas domésticas y áreas de almacenamiento de animales en granjas.

Los centros de tratamiento de residuos adecuados deben estar disponibles.

Durante todas las fases de uso descritas a continuación, use el equipo de protección personal (PPE) para protegerse y evitar posibles lesiones y / o contaminación corporal.

FRA – Le système RemDry doit être utilisé conformément à la réglementation environnementale locale et placé à une distance de sécurité des cours d'eau et des routes, des zones de travail, des zones domestiques et des zones de rétention des animaux dans les exploitations agricoles.

Des centres de traitement des déchets appropriés doivent être disponibles.

Pendant toutes les phases d'utilisation décrites ci-dessous, portez un équipement de protection individuelle (EPI) afin de vous protéger contre les blessures potentielles et / ou la contamination du corps

GER – Das RemDry-System muss gemäß den örtlichen Umweltvorschriften verwendet werden und in sicherem Abstand von Wasserläufen und Straßen, Arbeitsbereichen, häuslichen Bereichen und Tierhaltungsbereichen in landwirtschaftlichen Betrieben aufgestellt werden.

Es müssen geeignete Abfallbehandlungszentren zur Verfügung stehen.

Tragen Sie in allen nachfolgend beschriebenen Nutzungsphasen die persönliche Schutzausrüstung (PSA), um sich vor möglichen Verletzungen und / oder Körperverunreinigungen zu schützen

GRE – Το σύστημα RemDry πρέπει να χρησιμοποιείται σύμφωνα με τους τοπικούς περιβαλλοντικούς κανονισμούς και να τοποθετείται σε ασφαλή απόσταση από τα υδάτινα ρεύματα και τους δρόμους, τις περιοχές εργασίας, τις οικιακές περιοχές και τις περιοχές συγκράτησης ζώων στις γεωργικές εκμεταλλεύσεις.

Τα κατάλληλα κέντρα επεξεργασίας αποβλήτων πρέπει να είναι διαθέσιμα.

Κατά τη διάρκεια όλων των φάσεων χρήσης που περιγράφονται παρακάτω, φορέστε τον εξοπλισμό προσωπικής προστασίας (PPE) για να προστατεύσετε τον εαυτό σας, αποτρέποντας τυχόν τραυματισμούς ή / και μόλυνση του σώματος

HRV – RemDry mora se koristiti u skladu s lokalnim propisima o zaštiti okoliša i postavljen na sigurnu udaljenost od plovnih puteva i cesta, radnih područja, kućnih prostora i područja zadržavanja životinja na farmama.

Trebaju biti dostupni odgovarajući centri za obradu otpada.

Upotrijebite svu osobnu zaštitnu opremu (OZO) kako biste se zaštitili od mogućih ozljeda i / ili onečišćenja tijela u svim fazama uporabe opisanim u nastavku.

HUN – RemDry rendszer a helyi környezetvédelmi előírásoknak megfelelően kell használni, és biztonságos távolságra kell elhelyezni a vízi utaktól és az utaktól, a munkaterületekektől, a háztartásoktól és az állattartó helyektől a gazdaságokban.

Megfelelő hulladékkezelő központoknak kell rendelkezésre állniuk.

Használja az összes személyi védőfelszerelést (PPE), hogy megvédje magát az esetleges sérülésektől és / vagy testfertőzésektől az alábbiakban leírt valamennyi felhasználási szakaszban.

ITA – Il sistema RemDry deve essere utilizzato secondo le normative ambientali locali e deve essere posizionato a una distanza di sicurezza dai corsi d'acqua e dalle strade, dalle aree di lavoro, dalle aree domestiche e dalle aree di detenzione degli animali nelle fattorie.

Devono essere disponibili centri di trattamento dei rifiuti adeguati.

Durante tutte le fasi di utilizzo descritte di seguito, indossare l'equipaggiamento di protezione personale (DPI) per proteggersi da eventuali potenziali lesioni e / o contaminazione del corpo

NED – Remdry-systeem moet worden gebruikt in overeenstemming met de lokale milieuregelgeving en op een veilige afstand van waterlopen en wegen, werkgebieden, woongebieden en dierhouderuimten op boerderijen.

Goede afvalverwerkingscentra moeten beschikbaar zijn.

Draag tijdens alle hieronder beschreven gebruiksfases de persoonlijke beschermingsmiddelen (PBM) om uzelf te beschermen en voorkom eventuele verwondingen en / of lichaamsbesmetting

POL – System RemDry musi być używany zgodnie z lokalnymi przepisami dotyczącymi ochrony środowiska i powinien być umieszczony w bezpiecznej odległości od cieków wodnych i dróg, obszarów pracy, obszarów domowych i obszarów hodowli zwierząt w gospodarstwach

Odpowiednie centra przetwarzania odpadów muszą być dostępne

Podczas wszystkich opisanych poniżej faz użytkowania należy nosić środki ochrony osobistej (PPE), aby zabezpieczyć się przed potencjalnymi obrażeniami i / lub zanieczyszczeniem ciała

POR – O sistema RemDry precisa ser usado de acordo com as regulamentações ambientais locais e deve ser colocado a uma distância segura de cursos de água e estradas, áreas de trabalho, áreas domésticas e áreas de propriedade de animais em fazendas. Centros adequados de tratamento de resíduos precisam estar disponíveis

Durante todas as fases de uso descritas abaixo, use o equipamento de proteção individual (EPI) para se proteger, evitando possíveis lesões e / ou contaminação corporal.

ROM – Sistemul RemDry trebuie utilizat în conformitate cu reglementările locale de mediu și trebuie plasat la o distanță sigură de cursurile de apă și de drumurile, zonele de lucru, zonele domestice și zonele de fermă pentru animale.

Trebuie să fie disponibile centre adecvate de tratare a deșeurilor.

În timpul tuturor fazelor de utilizare descrise mai jos, purtați echipamentul individual de protecție (PPE) pentru a vă proteja împotriva eventualelor leziuni și / sau contaminări corporale

SLG – Sistem RemDry mora biti uporabljen v skladu z lokalnimi okoljskimi predpisi in nameščen na varni razdalji od vodotokov in cest, delovnih območij, domačih območij in območij za živinorejo na kmetijah.

Na voljo morajo biti ustrezni centri za ravnanje z odpadki.

V vseh spodaj opisanih fazah uporabe nosite osebno zaščitno opremo (OZO), da se zaščitite pred morebitnimi poškodbami in / ali onesnaženjem telesa.

SRB – РемДри мора се користити у складу са локалним еколошким прописима и постављен на сигурном растојању од водених путева и путева, радних површина, просторија кућа и подручја за задржавање животиња на фармама.

Одговарајући центри за третман отпада требају бити доступни.

Користите сву личну заштитну опрему (ППЕ) да бисте се заштитили од могућих повреда и / или контаминације тела у свим фазама употребе које су описане у наставку.

TUR – RemDry sisteminin yerel çevre düzenlemelerine uygun olarak kullanılması ve su sahaları ve yollardan, çalışma alanlarından, ev alanlarından ve çiftliklerdeki hayvan tutma alanlarından güvenli bir mesafeye yerleştirilmesi gerekir.

Uygun atık arıtma merkezleri bulunmalıdır.

Aşağıda açıklanan tüm kullanım aşamalarında, olası yaralanma ve / veya vücut kirlenmesini önlemek için kendinizi korumak için kişisel koruma ekipmanını (KKD) kullanın



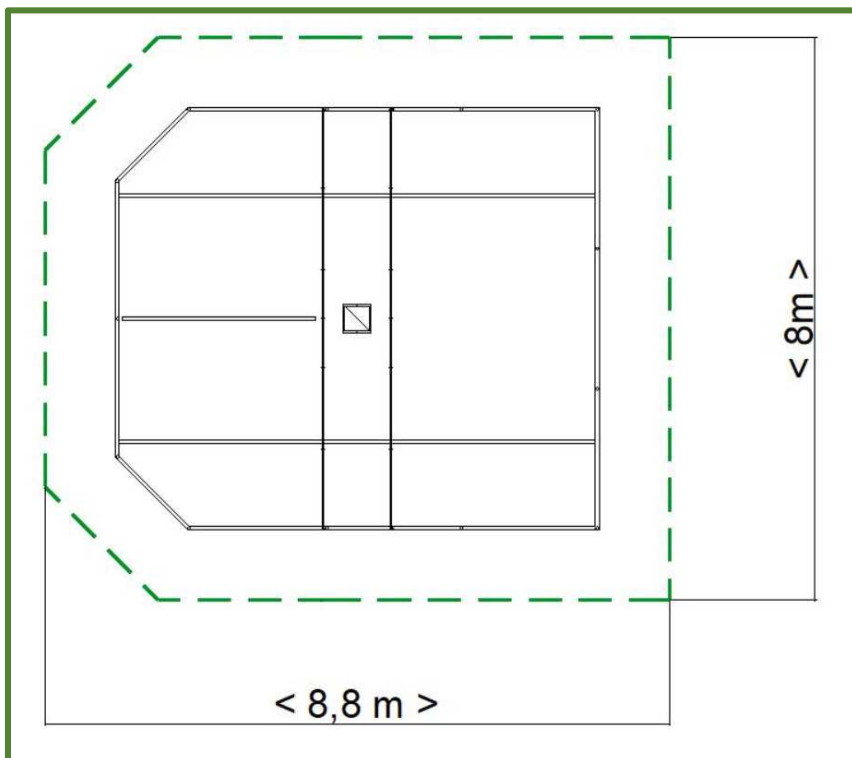
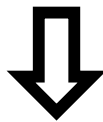
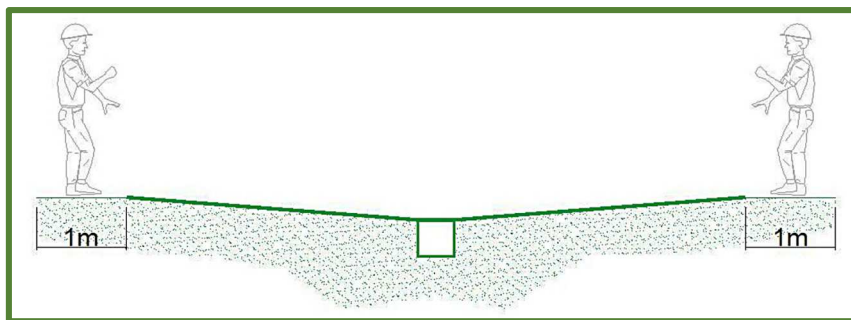
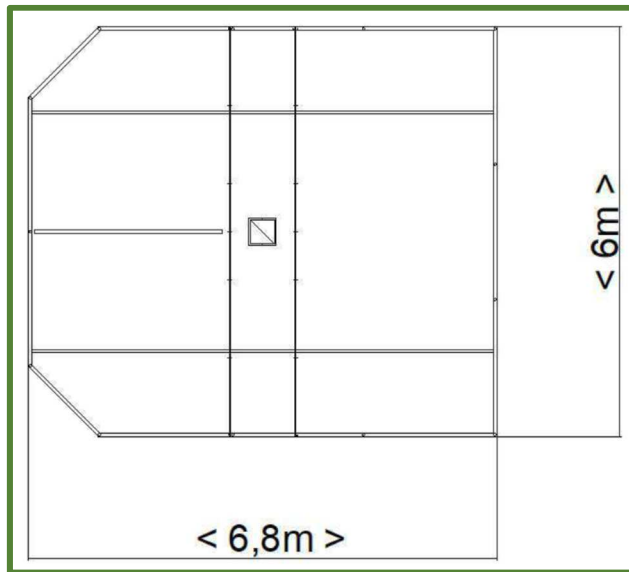

1.

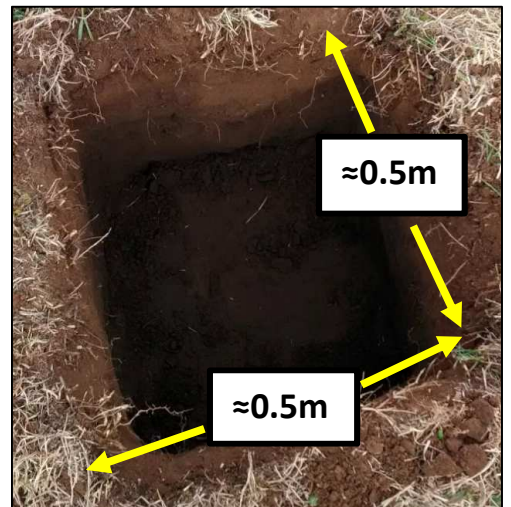
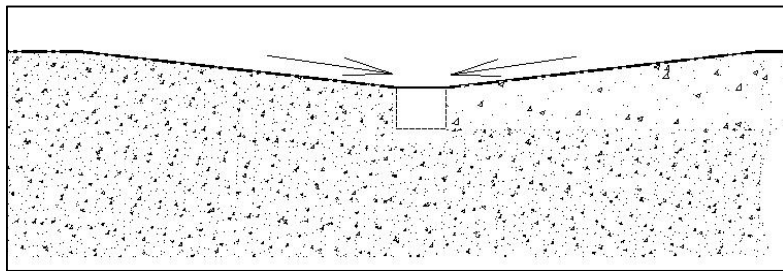
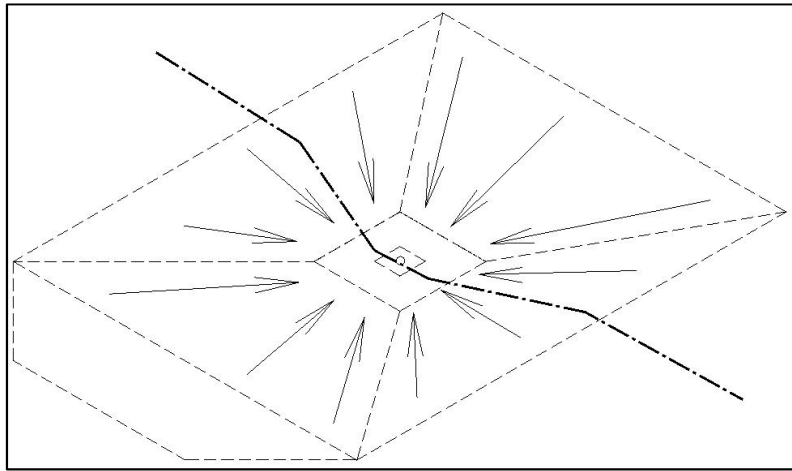

2.

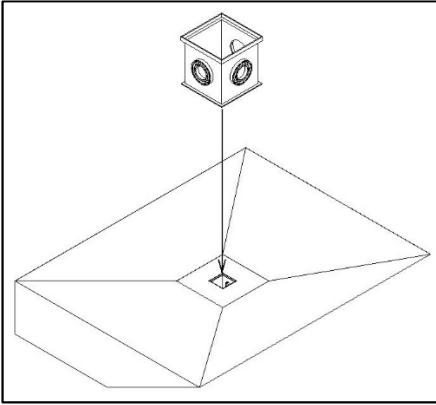

3.

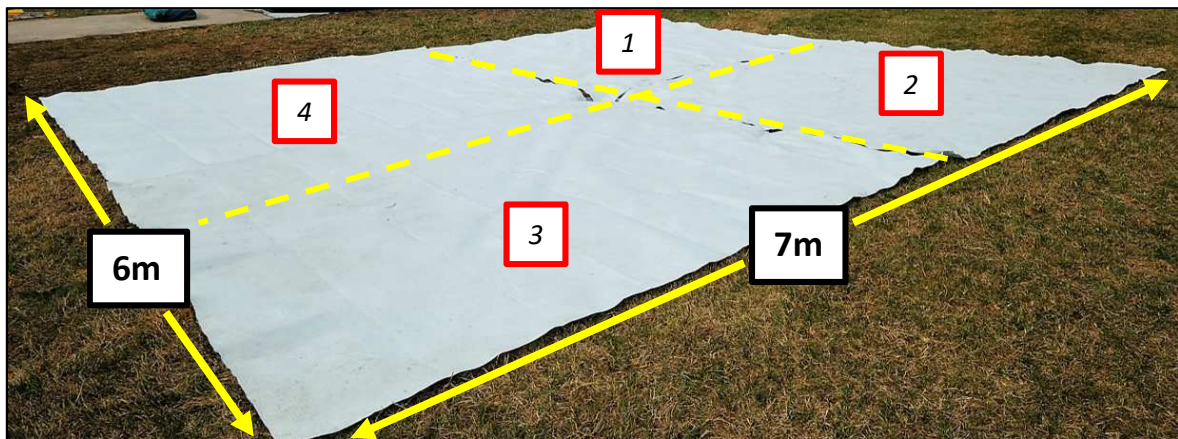
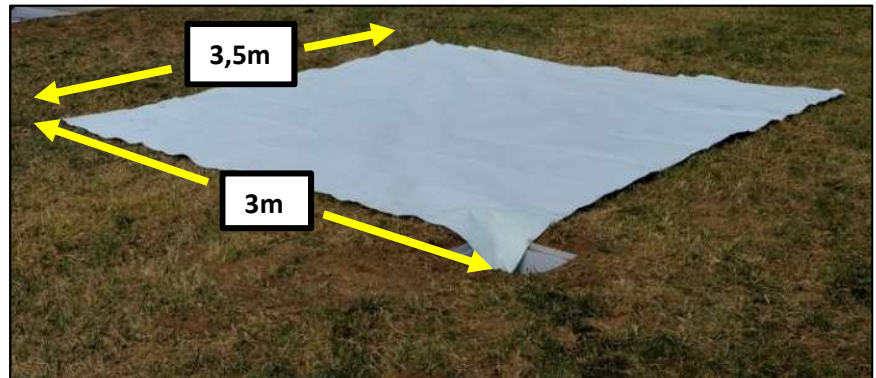
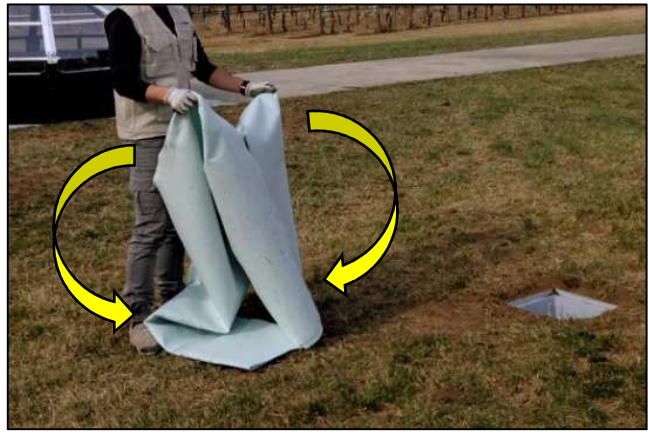
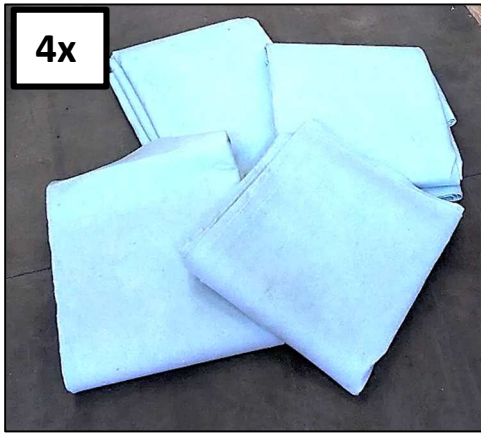

4.



5.

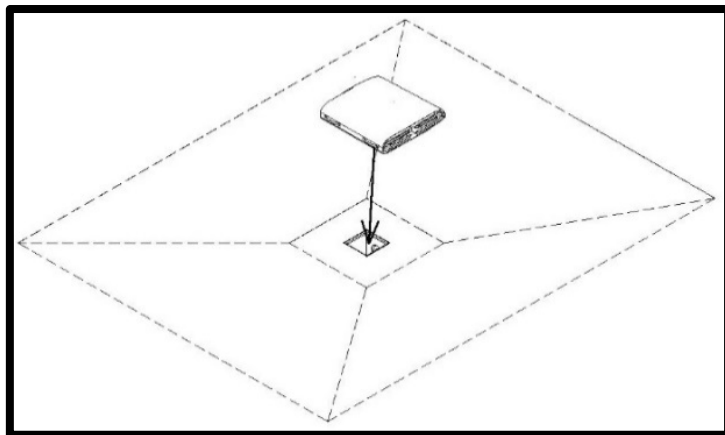

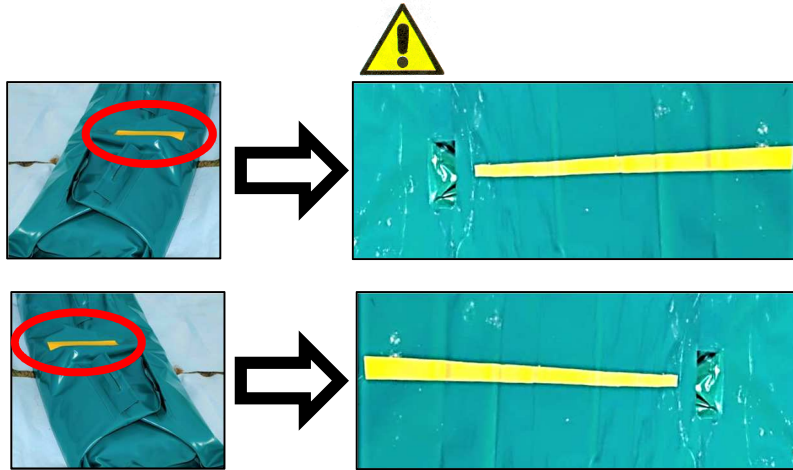

6.

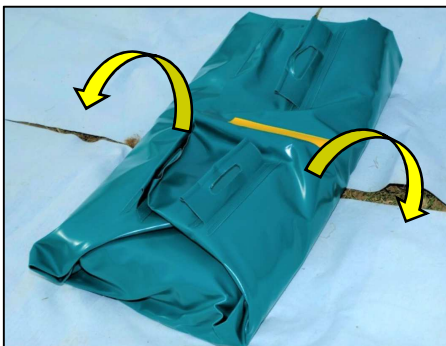





7.

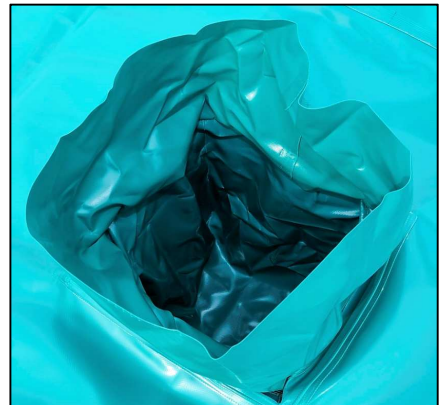
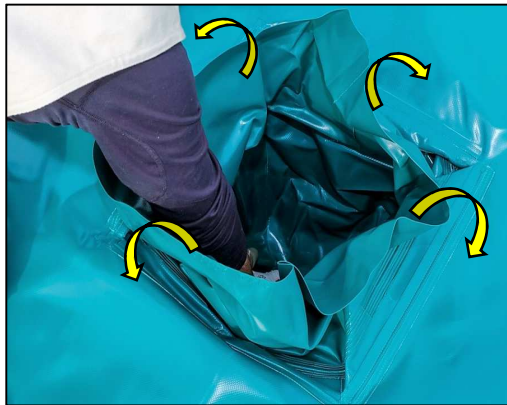

8.

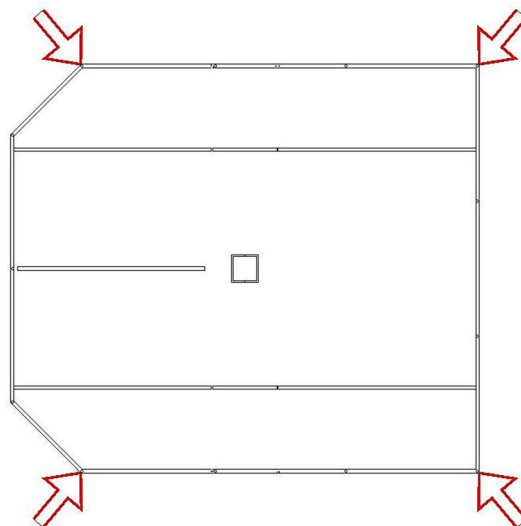

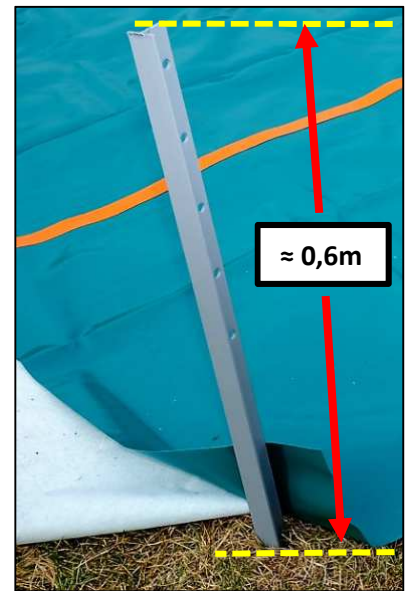
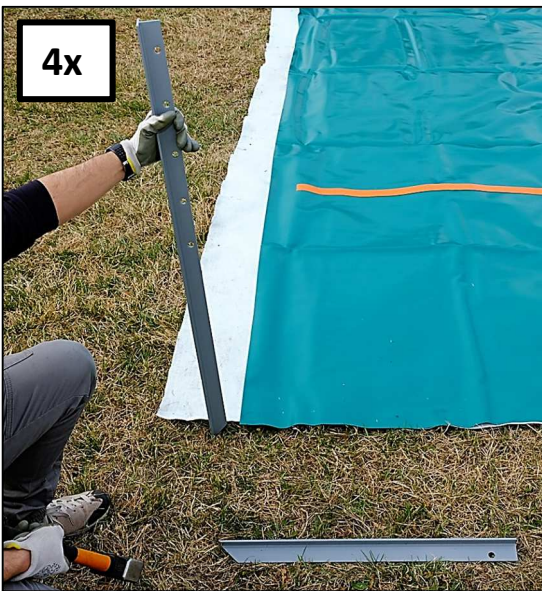

9.

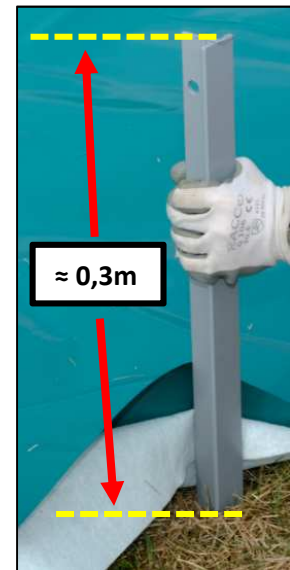
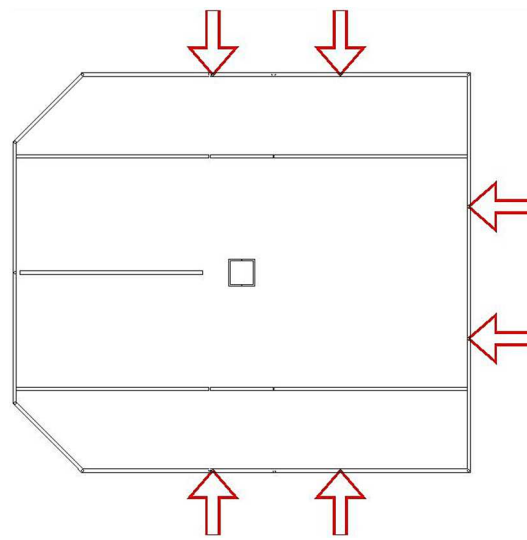

10.

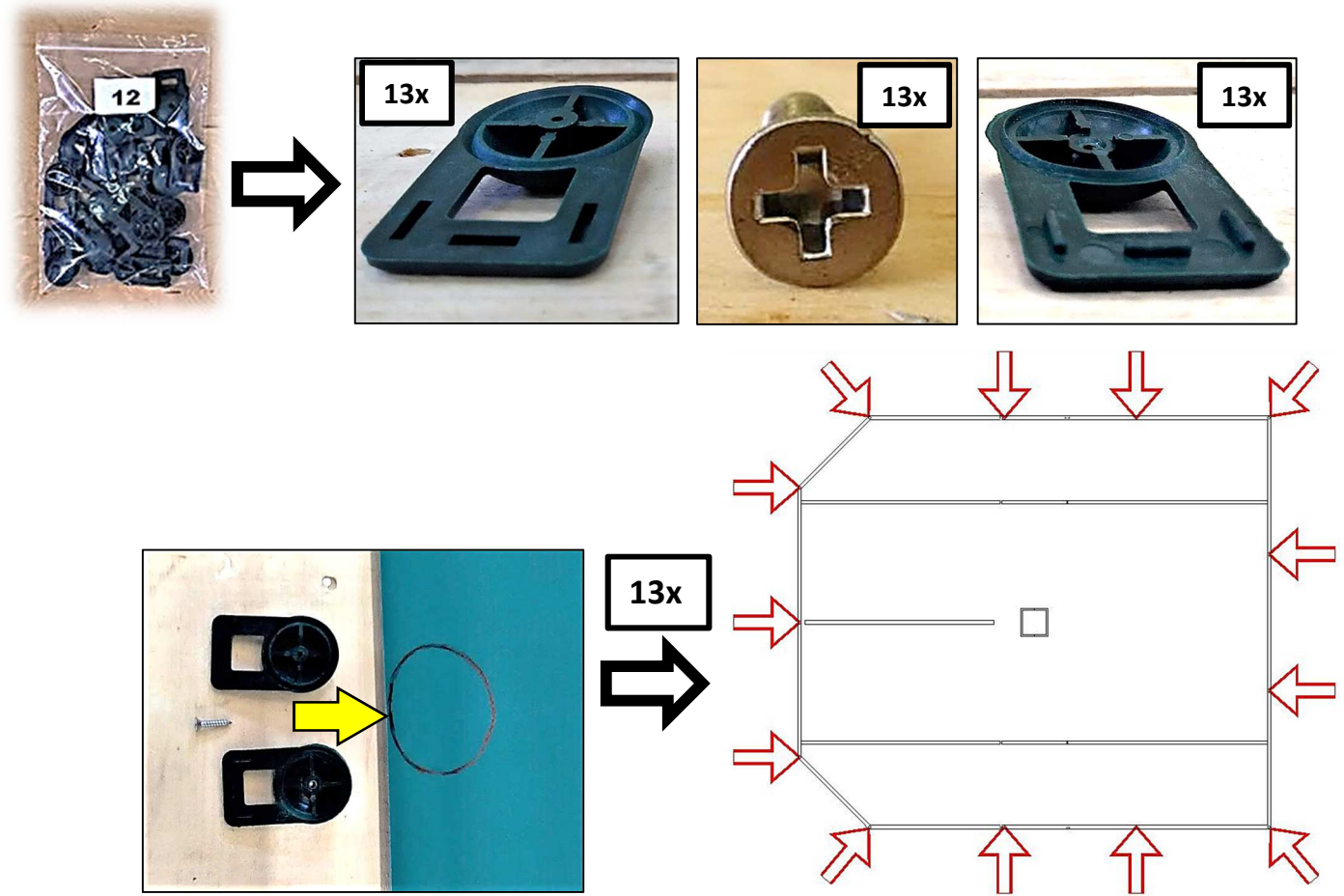

11.

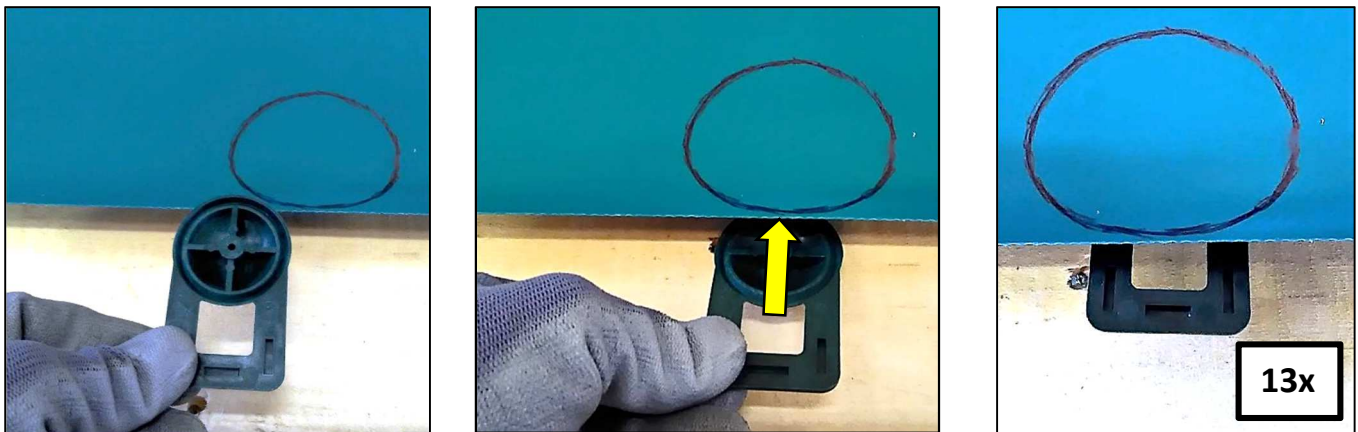

12.

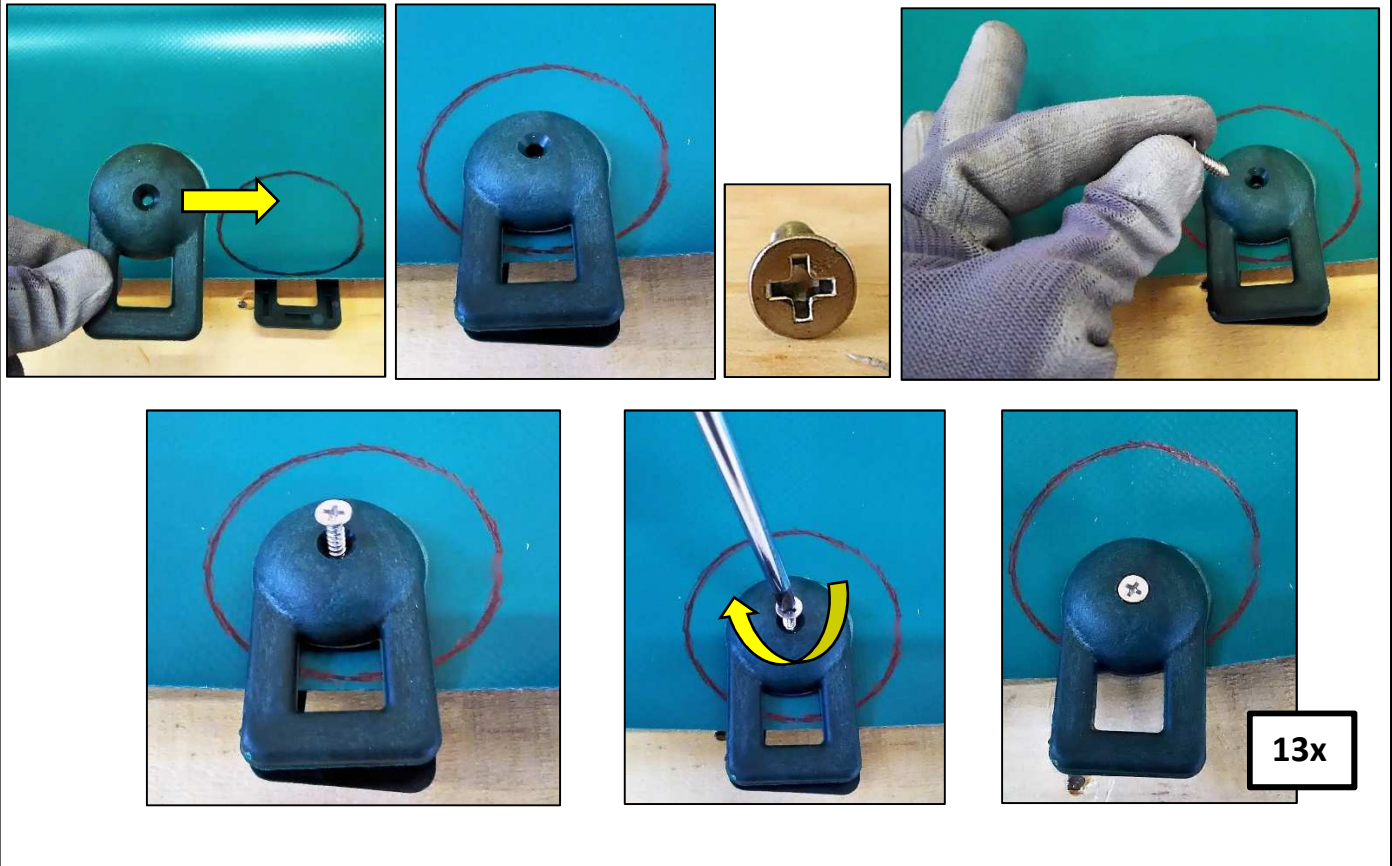

13.

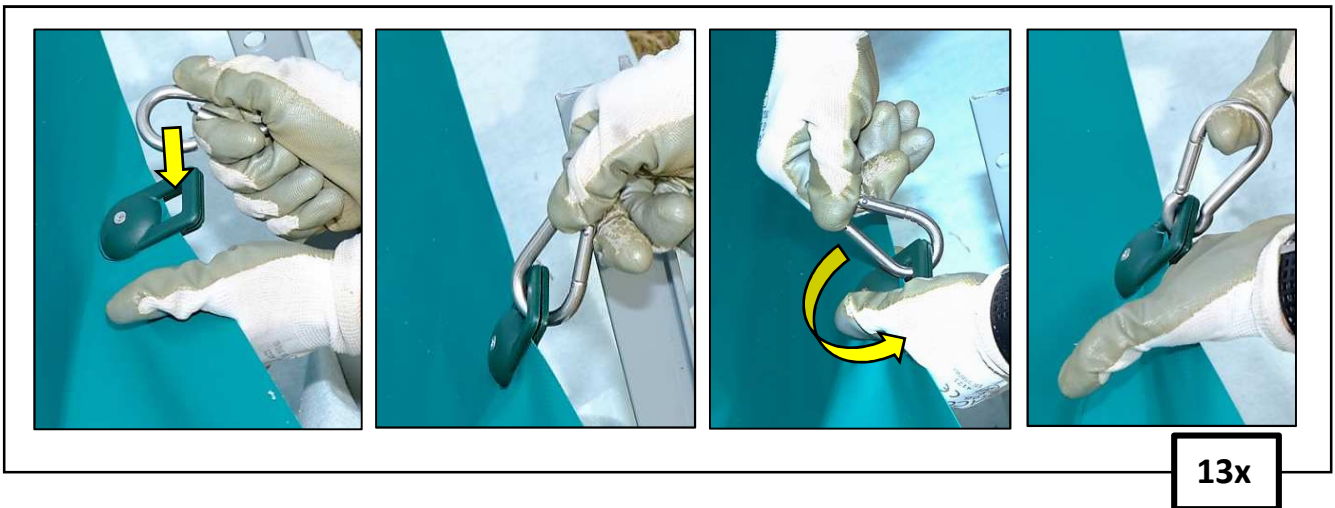

14.



15.

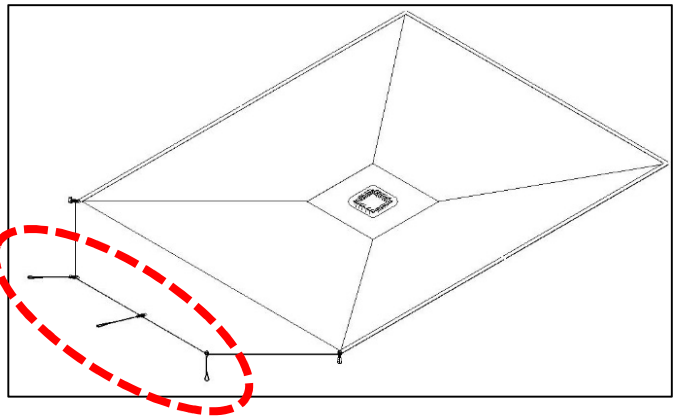
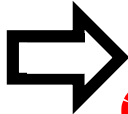
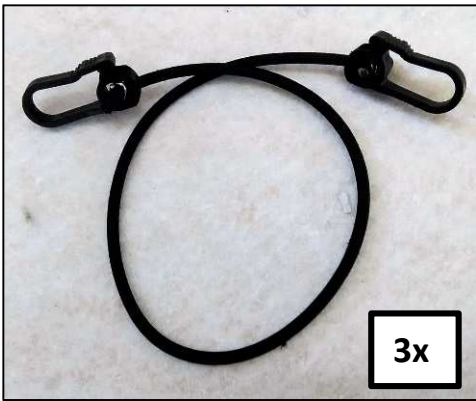

16.

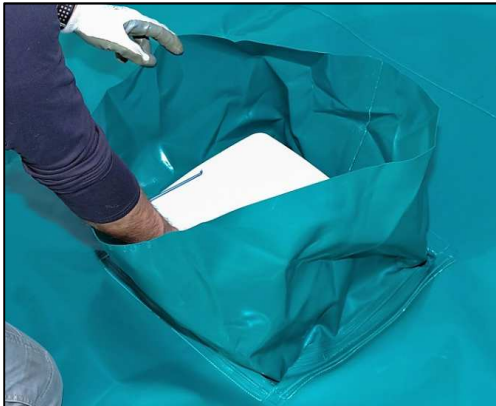
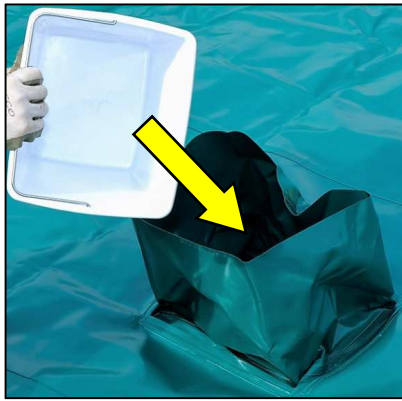

17.



18.



19.



20.



21.



22.



23.



24.

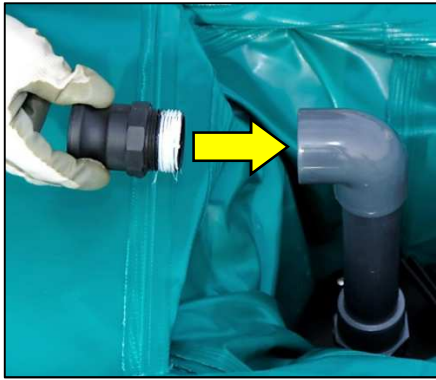

25.

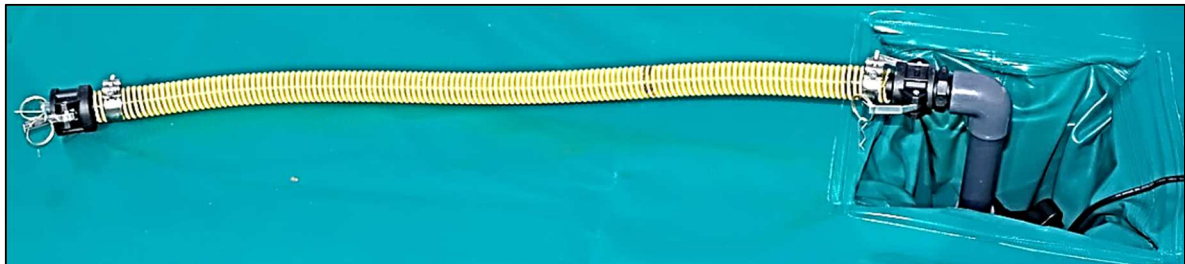
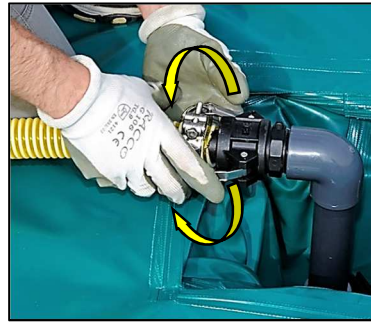
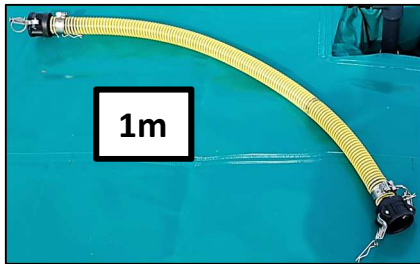

26.

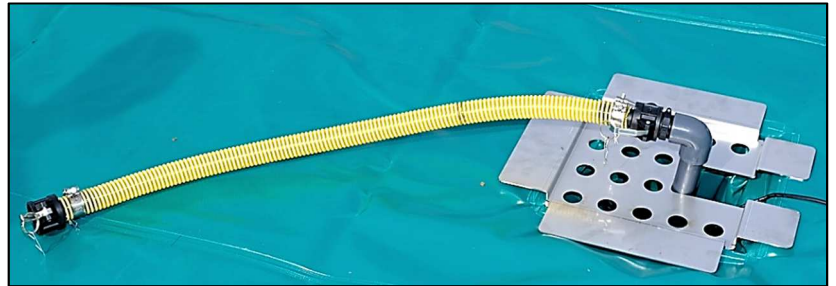
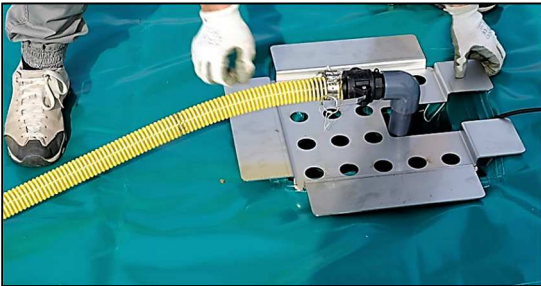
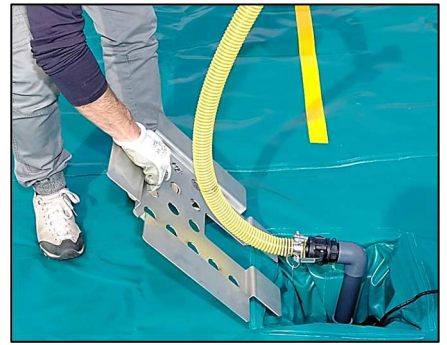
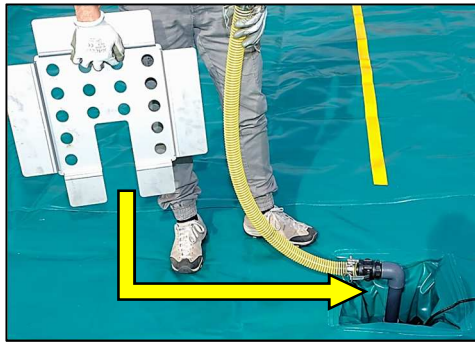
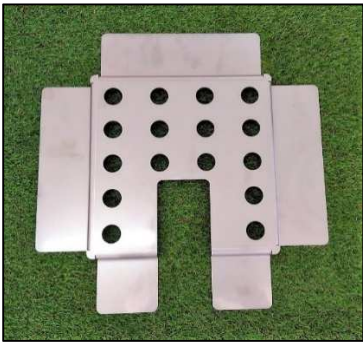

27.

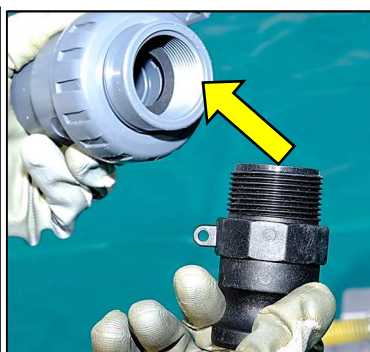
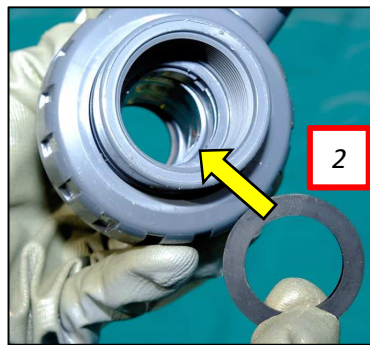
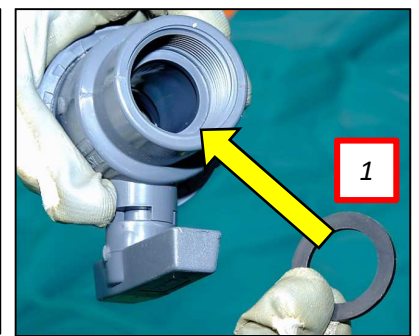
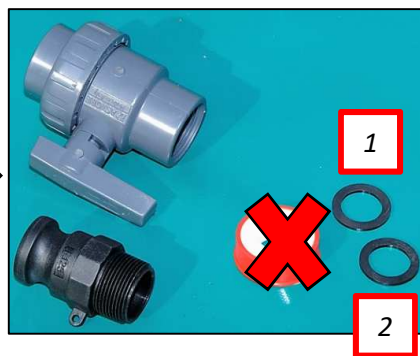

28.

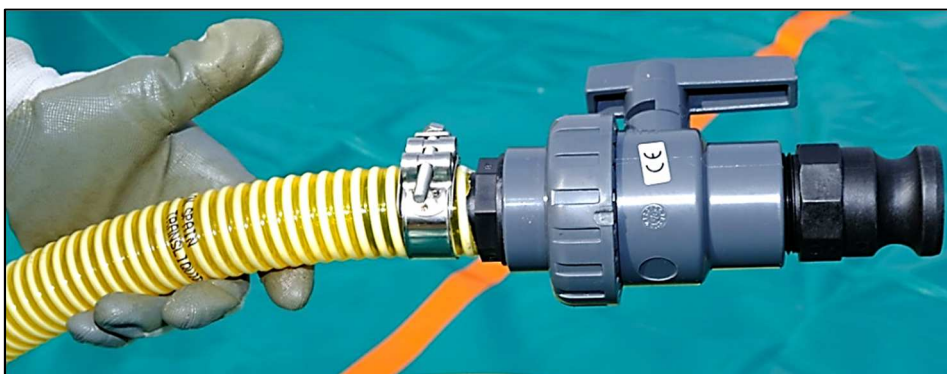
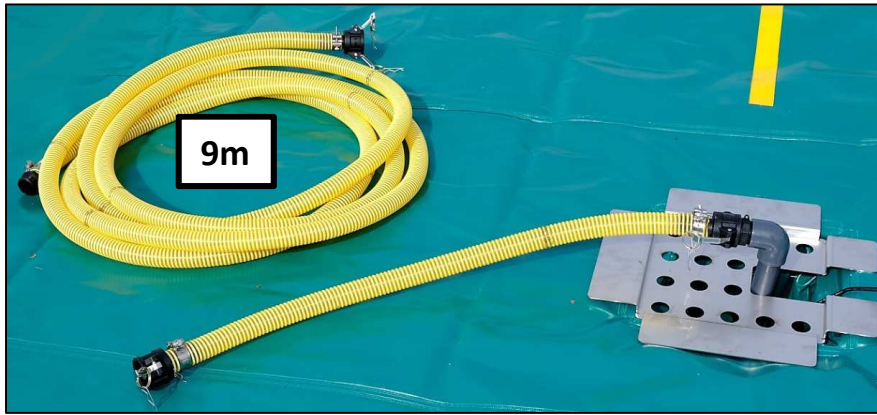

29.

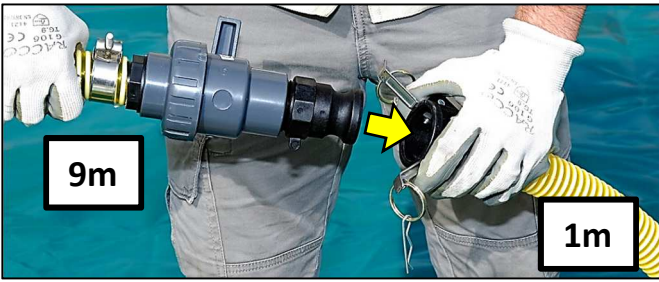

30.



